

TITAN

Cordless chainsaw 18V 25cm

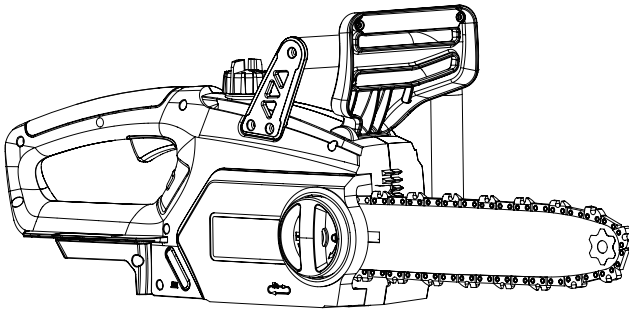

TTI932CHN



CAUTION: Read the instructions before using the product.

Let's get started...

These instructions are for your safety. Please read through them thoroughly before use and retain them for future reference.



Getting **started**...

02

Safety information 03

Your **product** 19

Before you start 21



In more **detail**...

29

Product functions 30

Operation 33

Care and **maintenance** 42

Trouble shooting 48

Recycling and **disposal** 49

Guarantee 50

Customer Care and **Technical Helpline** 52

Availability of Spare Parts 53

Technical specifications 54

Declaration of conformity 56

Safety warnings

General power tool safety warnings



WARNING! Read all safety warnings, instructions, illustrations and specifications provided with this power tool. *Failure to follow all instructions listed below may result in electric shock, fire and/or serious injury.*

Save all warnings and instructions for future reference.

The term “power tool” in the warnings refers to your mains-operated (corded) power tool or battery-operated (cordless) power tool.

Work area safety

- 1. Keep work area clean and well lit.** *Cluttered or dark areas invite accidents.*
- 2. Do not operate power tools in explosive atmospheres, such as in the presence of flammable liquids, gases or dust.** *Power tools create sparks which may ignite the dust or fumes.*
- 3. Keep children and bystanders away while operating a power tool.** *Distractions can cause you to lose control.*

Electrical safety

- 1. Power tool plugs must match the outlet. Never modify the plug in any way.** *Do not use any adapter plugs with earthed (grounded) power tools.*

Unmodified plugs and matching outlets will reduce risk of electric shock.

- 2. Avoid body contact with earthed or grounded surfaces, such as pipes, radiators, ranges and refrigerators.** *There is an increased risk of electric shock if your body is earthed or grounded.*
- 3. Do not expose power tools to rain or wet conditions.** *Water entering a power tool will increase the risk of electric shock.*
- 4. Do not abuse the cord. Never use the cord for carrying, pulling or unplugging the power tool. Keep cord away from heat, oil, sharp edges or moving parts.** *Damaged or entangled cords increase the risk of electric shock.*
- 5. When operating a power tool outdoors, use an extension cord suitable for outdoor use.** *Use of a cord suitable for outdoor use reduces the risk of electric shock.*
- 6. If operating a power tool in a damp location is unavoidable, use a residual current device (RCD) protected supply.** *Use of an RCD reduces the risk of electric shock.*

Personal safety

- 1. Stay alert, watch what you are doing and use common sense when operating a power tool. Do not use a power tool while you are tired or under the influence of drugs, alcohol or medication.** *A moment of inattention while operating power tools may result in serious personal injury.*
- 2. Use personal protective equipment. Always wear**

eye protection. *Protective equipment such as dust mask, non-skid safety shoes, hard hat, or hearing protection used for appropriate conditions will reduce personal injuries.*

- 3. Prevent unintentional starting.** Ensure the switch is in the off-position before connecting to power source and/or battery pack, picking up or carrying the tool. *Carrying power tools with your finger on the switch or energising power tools that have the switch on invites accidents.*
- 4. Remove any adjusting key or wrench before turning the power tool on.** *A wrench or a key left attached to a rotating part of the power tool may result in personal injury.*
- 5. Do not overreach. Keep proper footing and balance at all times.** *This enables better control of the power tool in unexpected situations.*
- 6. Dress properly. Do not wear loose clothing or jewellery. Keep your hair, clothing and gloves away from moving parts.** *Loose clothes, jewellery or long hair can be caught in moving parts.*
- 7. If devices are provided for the connection of dust extraction and collection facilities, ensure these are connected and properly used.** *Use of dust collection can reduce dust-related hazards.*
- 8. Do not let familiarity gained from frequent use of tools allow you to become complacent and ignore tool safety principles.** *A careless action can cause severe injury within a fraction of a second.*

Power tool use and care

- 1. Do not force the power tool. Use the correct power tool for your application.** *The correct power tool will do the job better and safer at the rate for which it was designed.*
- 2. Do not use the power tool if the switch does not turn it on and off.** *Any power tool that cannot be controlled with the switch is dangerous and must be repaired.*
- 3. Disconnect the plug from the power source and/or remove the battery pack, if detachable, from the power tool before making any adjustments, changing accessories, or storing power tools.** *Such preventive safety measures reduce the risk of starting the power tool accidentally.*
- 4. Store idle power tools out of the reach of children and do not allow persons unfamiliar with the power tool or these instructions to operate the power tool.** *Power tools are dangerous in the hands of untrained users.*
- 5. Maintain power tools. Check for misalignment or binding of moving parts, breakage of parts and any other condition that may affect the power tool's operation. If damaged, have the power tool repaired before use.** *Many accidents are caused by poorly maintained power tools.*
- 6. Keep cutting tools sharp and clean.** *Properly maintained cutting tools with sharp cutting edges are less likely to bind and are easier to control.*
- 7. Use the power tool, accessories and tool bits etc. in accordance with these instructions, taking into account the working conditions and the work to**

be performed. *Use of the power tool for operations different from those intended could result in a hazardous situation.*

- 8. Keep handles and grasping surfaces dry, clean and free from oil and grease.** *Slippery handles and grasping surfaces do not allow for safe handling and control of the tool in unexpected situations.*

Battery tool use and care

- 1. Recharge only with the charger specified by the manufacturer.** *A charger that is suitable for one type of battery pack may create a risk of fire when used with another battery pack.*
- 2. Use power tools only with specifically designated battery packs.** *Use of any other battery packs may create a risk of injury and fire.*
- 3. When battery pack is not in use, keep it away from other metal objects, like paper clips, coins, keys, nails, screws or other small metal objects that can make a connection from one terminal to another.** *Shorting the battery terminals together may cause burns or a fire.*
- 4. Under abusive conditions, liquid may be ejected from the battery; avoid contact. If contact accidentally occurs, flush with water. If liquid contacts eyes, additionally seek medical help.** *Liquid ejected from the battery may cause irritation or burns.*
- 5. Do not use battery pack or tool that is damaged or modified.** *Damaged or modified batteries may exhibit unpredictable behaviour resulting in fire,*

explosion or risk of injury.

- 6. Do not expose a battery pack or tool to fire or excessive temperature.** *Exposure to fire or temperature above 130 °C may cause explosion.*
- 7. Follow all charging instructions and do not charge the battery pack or tool outside the temperature range specified in the instructions.** *Charging improperly or at temperatures outside the specified range may damage the battery and increase the risk of fire.*

Service

- 1. Have your power tools serviced by a qualified repair person using only identical replacement parts.** *This will ensure that safety of the power tool is maintained.*
- 2. Never service damaged battery packs.** *Service of battery packs should only be performed by the manufacturer or authorized service providers.*

Safety instructions for chain saws

General chain saw safety warnings:

- 1. Keep all parts of the body away from the saw chain when the chain saw is operating.** *Before you start the chain saw, make sure the saw chain is not contacting anything. A moment of inattention while operating chain saws may cause entanglement of your clothing or body with the saw chain.*
- 2. Always hold the chain saw with your right hand on the rear handle and your left hand on the front handle.** *Holding the chain saw with a reversed hand*

configuration increases the risk of personal injury and should never be done.

- 3. Hold the chain saw by insulated gripping surfaces only, because the saw chain may contact hidden wiring.** *Saw chains contacting a "live" wire may make exposed metal parts of the power tool "live" and could give the operator an electric shock.*
- 4. Wear eye protection. Further protective equipment for hearing, head, hands, legs and feet is recommended.** *Adequate protective equipment will reduce personal injury from flying debris or accidental contact with the saw chain.*
- 5. Do not operate a chain saw in a tree, on a ladder, from a rooftop, or any unstable support.** *Operation of a chain saw in this manner could result in serious personal injury.*
- 6. Always keep proper footing and operate the chain saw only when standing on fixed, secure and level surface.** *Slippery or unstable surfaces may cause a loss of balance or control of the chain saw.*
- 7. When cutting a limb that is under tension be alert for spring back. When the tension in the wood fibres is released, the spring loaded limb may strike the operator and/or throw the chain saw out of control.**
- 8. Use extreme caution when cutting brush and saplings.** *The slender material may catch the saw chain and be whipped toward you or pull you off balance.*

9. **Carry the chain saw by the front handle with the chain saw switched off and away from your body. When transporting or storing the chain saw, always fit the guide bar cover. *Proper handling of the chain saw will reduce the likelihood of accidental contact with the moving saw chain.***
10. **Follow instructions for lubricating, chain tensioning and changing the bar and chain. *Improperly tensioned or lubricated chain may either break or increase the chance for kickback.***
11. **Cut wood only. Do not use chain saw for purposes not intended. For example: do not use chain saw for cutting metal, plastic, masonry or non-wood building materials. *Use of the chain saw for operations different than intended could result in a hazardous situation.***
12. **Do not attempt to fell a tree until you have an understanding of the risks and how to avoid them. *Serious injury could occur to the operator or bystanders while felling a tree.***
13. **Follow all instructions when clearing jammed material, storing or servicing the chain saw. Make sure the switch is off and the battery pack is removed. *Unexpected actuation of the chain saw while clearing jammed material or servicing may result in serious personal injury.***
14. **Keep handles dry, clean, and free from oil and grease. *Greasy, oily handles are slippery causing loss of control.***
15. **Pay attention to national and local regulations. *National and local regulations may restrict the use of***

this product.

16. Only use replacement guide bars and saw chains specified by the manufacturer or equivalent replacements. Using non-approved cutting attachments can result in personal injuries and damage to property.
17. Before using the product and after any impact or dropping, check for signs of wear or damage and repair as necessary.
18. Never remove or modify any guard or safety component. Ensure that guards and other safety components necessary for machine operation are in position, in good working condition and properly maintained to avoid injuries.
19. Training of all operation is necessary for first-time and inexperienced operator.
20. Remove branches in section.

Causes and operator prevention of kickback

Kickback may occur when the nose or tip of the guide bar touches an object, or when the wood closes in and pinches the saw chain in the cut.

Tip contact in some cases may cause a sudden reverse reaction, kicking the guide bar up and back towards the operator.

Pinching the saw chain along the top of the guide bar may push the guide bar rapidly back towards the operator.

Either of these reactions may cause you to lose control of the saw which could result in serious personal injury. Do not rely exclusively upon the safety devices built into

your saw. As a product user, you should take several steps to keep your cutting jobs free from accident or injury.

Kickback is the result of tool misuse and/or incorrect operating procedures or conditions and can be avoided by taking proper precautions as given below:

- 1. Maintain a firm grip, with thumbs and fingers encircling the chain saw handles, with both hands on the saw and position your body and arm to allow you to resist kickback forces.**
Kickback forces can be controlled by the operator, if proper precautions are taken. Do not let go of the product.
- 2. Do not overreach and do not cut above shoulder height.** *This helps prevent unintended tip contact and enables better control of the chain saw in unexpected situations.*
- 3. Only use replacement guide bars and chains specified by the manufacturer.** *Incorrect replacement guide bars and saw chains may cause chain breakage and/or kickback.*
- 4. Follow the manufacturer's sharpening and maintenance instructions for the saw chain.** *Decreasing the depth gauge height can lead to increased kickback.*

Additional safety warnings for battery pack

- 1. Battery pack needs to be charged before use.**
Always refer to the charger's instruction and charge it properly.
- 2. Remove the battery pack from the product when**

- not in use.
3. **Don't maintain the battery pack on the charger when not in use.**
 4. **After extended periods of storage, it may be necessary to charge and discharge the battery pack several times to obtain the maximum performance.**
 5. **Longer life and better performance can be obtained if the battery is charged when the air temperature is between 18°C and 24°C. Do not charge the battery in air temperature below 5°C or above 40°C. This is important as it can prevent serious damage to the battery.**
 6. **Do not charge battery in a damp or wet location. Following this rule will reduce the risk of electric shock.**
 7. **Do not disassemble the battery and avoid mechanical damage to the battery. Risk of short circuit and fumes may be emitted. Ensure fresh air and seek medical assistance in the event of discomfort.**
 8. **When disposing of battery pack, keep the battery pack of different electrochemical systems separate from each other.**

Vibration and noise reduction

To reduce the impact of noise and vibration emission, limit the time of operation, use low-vibration and low-noise operating modes as well as wear personal protective equipment.

Take the following points into account to minimise the

vibration and noise exposure risks:

1. Only use the product as intended by its design and these instructions.
2. Ensure that the product is in good condition and well maintained.
3. Use correct attachments for the product and ensure they are in good condition.
4. Keep tight grip on the handles/grip surface.
5. Maintain this product in accordance with these instructions and keep it well lubricated (where appropriate).
6. Plan your work schedule to spread any high vibration tool use across a longer period of time.
7. Prolonged use of the product exposes the user to vibrations that can cause a range of conditions collectively known as hand-arm vibration syndrome (HAVS) e.g. fingers going white; as well as specific diseases such as carpal tunnel syndrome. To reduce this risk when using the product, always wear protective gloves and keep your hands warm.

Emergency

Familiarise yourself with the use of this product by means of this instruction manual. Memorise the safety directions and follow them to the letter. This will help to prevent risks and hazards.

1. **Always be alert when using this product, so that you can recognise and handle risks early.** *Fast intervention can prevent serious injury and damage to property.*
2. **Switch the product off and remove the battery**

pack if there are malfunctions. *Have the product checked by a qualified professional and repaired, if necessary, before you operate it again.*

Residual risks

Even if you are operating this product in accordance with all the safety requirements, potential risks of injury and damage remain. The following dangers can arise in connection with the structure and design of this product:

1. Health defects resulting from vibration emission if the product is being used over long periods of time or not adequately managed and properly maintained.
2. Injuries and damage to property due to broken attachments or the sudden impact of hidden objects during use.
3. Danger of injury and property damage caused by flying objects.



WARNING! This product produces an electromagnetic field during operation! This field may under some circumstances interfere with active or passive medical implants! To reduce the risk of serious or fatal injury, we recommend persons with medical implants to consult their doctor and the medical implant manufacturer before operating this product!

Symbols

On the product, the rating label and within these instructions you will find among others the following symbols and abbreviations. Familiarise yourself with them to reduce hazards like personal injuries and damage to property.

V	Volt, (direct current voltage)	mAh	Milliampere per hour
/min or min ⁻¹	Per minute	°C	Degree Celsius
g	Gram	kg	Kilogram
mm	Millimetre	m	Metre
cm	Centimetre	m/s ²	Metres per second squared

dB(A) Decibel (A-rated) Lock / to tighten or secure.



Read the instruction manual.



Unlock / to loosen.



Note / Remark.



Caution / Warning.

xxWyy

Manufacturing date code; year of manufacturing (20xx) and week of manufacturing (Wyy)



Wear hearing protection.



Wear eye protection.



Wear a dust mask.



Wear head protection, where there is a risk of falling objects.



Wear respiratory protection.



Wear protective gloves.



Wear protective, slip-resistant footwear.



Wear tight-fitted protective clothes.



Use appropriate protection for foot-leg and hand-arm.



Switch the product off and remove battery pack before assembly, cleaning, adjustments, maintenance, storage and transportation.



This product is of protection class III.



Do not expose the product to rain or wet conditions (moisture).



Keep hands away from moving cutting device!



Objects thrown by the product could hit the user or other bystanders. Always ensure that other people and pets remain at a safe distance from the product when it is in operation. In general, children must not come near the area where the product is.

Minimum distance is 10m.



Kickback! Tip contact may cause the guide bar to move suddenly upward and backwards what may cause serious injury to user.



Contact of the guide bar tip with any object should be avoided.



Always use the product with two hands. Do not use one handed when operating the product.



Chain oil fill.



Correct direction of cutting-teeth.

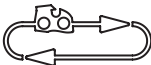

Beware of chain saw kickback and avoid contact with bar tip



Cutting of fingers or hand.



Guaranteed sound power level value in 99 dB.



WEEE symbol. Waste electrical products should not be disposed of with household waste. Please recycle where facilities exist. Check with your Local Authority or local store for recycling advice.



Crossed out dust bin. Batteries and battery packs should not be disposed of with household waste. Please recycle where facilities exist. Check with your Local Authority or local store for recycling advice.



Do not dispose of battery packs in rivers or immerse in water.



Do not dispose of battery packs in fire. They will explode and cause injury.



Do not expose battery packs to heat in excess of 40 °C.
Do not charge or store the battery pack in temperatures below 5 °C (41 °F) and above 40 °C (104 °F).



The product complies with the applicable European directives and an evaluation method of conformity for these directives was done.



UK Conformity Assessed.

Your product

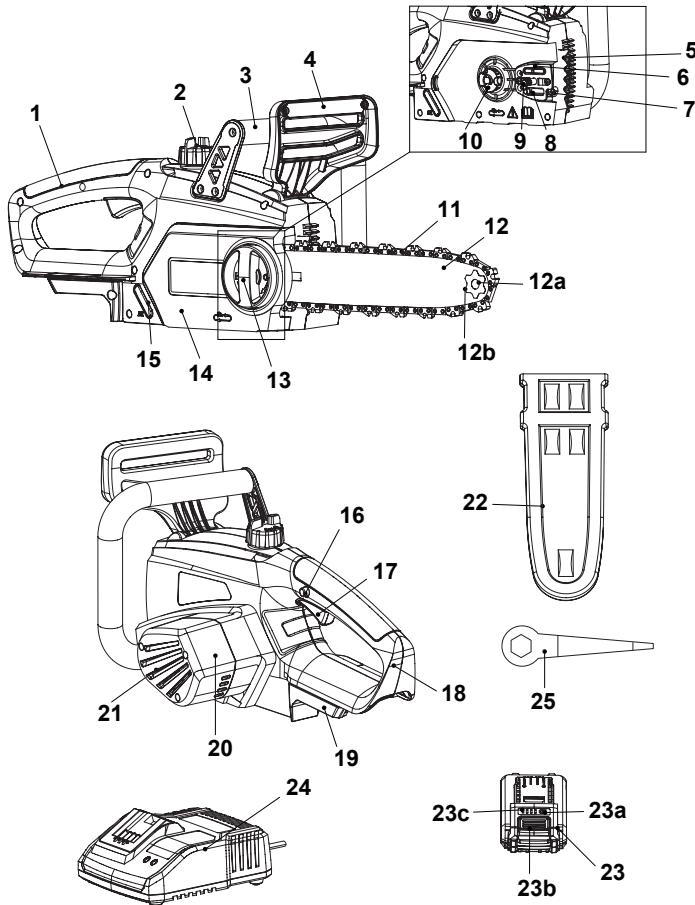

- | | |
|--|----------------------|
| 1. Rear handle | 10. Drive sprocket |
| 2. Oil tank cap | 11. Saw chain |
| 3. Front handle | 12. Guide bar |
| 4. Front safeguard (chain brake lever) | a. Sprocket wheel |
| 5. Spiked bumper | b. Lubrication hole |
| 6. Oiling port | 13. Locking wheel |
| 7. Tension screw | 14. Chain saw cover |
| 8. Tension pin | a. Spigot* |
| 9. Mounting bolt | 15. Oil level window |

- 16. Lock-off button
- 17. On/off switch
- 18. Rear safeguard
- 19. Battery docking port
- 20. Motor housing
 - a. Motor*
- 21. Air vents
- 22. Guide bar cover
- 23. Battery pack
 - a. Battery capacity button
 - b. Release button
 - c. Battery capacity indicators
- 24. Charger
- 25. Multitool



NOTE: Parts marked with * are not shown in this overview. Please refer to the respective part in the instruction manual.

Unpacking

1. Unpack all parts and lay them on a flat, stable surface.
2. Remove all packing materials and shipping devices if applicable.
3. Make sure the delivery contents are complete and free of any damage. If you find that parts are missing or show damage do not use the product but contact your dealer. Using an incomplete or damaged product represents a hazard to people and property.
4. Ensure that you have all the accessories and tools needed for assembly and operation. This also includes suitable personal protective equipment.



WARNING! The product and the packaging are not children's toys! Children must not play with plastic bags, sheets and small parts! There is a danger of choking and suffocation!

You will need

(items not supplied)

Suitable personal protective equipment
 Suitable screwdriver
 Lubrication oil for saw chain
 Grease for sprocket wheel
 Nose lubrication
 Sharpening set (chain file)

(items supplied)

Saw chain (11)
 Guide bar (12)
 Guide bar cover (22)
 Battery pack (23)
 Charger (24) and its manual



NOTE: The accessories required depend on the intended application. Ask your dealer for advice.

Setup



WARNING! The product must be fully assembled before operation! Do not use a product that is only partly assembled or assembled with damaged parts!

Follow the assembly instructions step-by-step and use the pictures provided as a visual guide to easily assemble the product! Before using the product, familiarise yourself with the operating features read the entire instruction manual paying particular attention to the safety rules and operating procedures. Do not connect the product to battery pack (23) before it is completely assembled!



NOTE: Take care of small parts that are removed during assembly or when making adjustments. Keep them secure to avoid loss.

Saw chain and guide bar

Assemble the guide bar (12) and saw chain (11) before operation.

Use only the guide bar (12) and saw chain (11) according to the technical parameter of this product.



WARNING! Always use a saw chain designed as "low-kickback" or a saw chain which meets the low-kickback requirements! A standard saw chain (a chain which does not have the kickback reducing guard links) should only be used by an experienced professional operator. Nevertheless, a low-kickback saw chain does not completely eliminate kickback! A low-kickback or "safety" chain should never be regarded as complete protection against injury! Therefore always use a low-kickback saw chain in conjunction with other kickback protection devices such as the front safeguard (chain brake lever) (4)!



WARNING! Pull the front safeguard (chain brake lever) (4) fully backward to disengage the chain brake.

1. Place the product on a suitable flat surface.
2. Unscrew the locking wheel (13) anticlockwise and then remove it together with the chain saw cove (14) (Fig. 1).

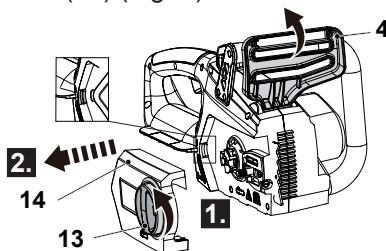

Fig. 1

3. Spread the saw chain (11) out with the cutting edges of the chain pointing in the direction of rotation. Slide the saw chain (11) into the groove around the guide bar (12). Ensure saw chain (11) is installed in correct direction of rotation (Fig. 2).

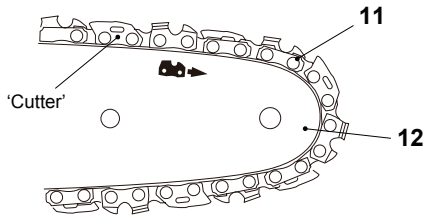

Fig. 2



WARNING! The direction of the saw chain 'cutters' must be same as indicated by the symbol and arrow on the guide bar!

- Align the saw chain (11) and guide bar (12) assembly with the drive sprocket (10) and the mounting bolt (9). Lay the saw chain (11) around the drive sprocket (10) and then lower the guide bar (12) to install it to the mounting bolt (9) (Fig. 3).
- Make sure the tension pin (8) is inserted into the lower hole on the guide bar (12). Screwing the tension screw (7) in to adjust the tension pin (8) to the end of slot with one suitable screwdriver.

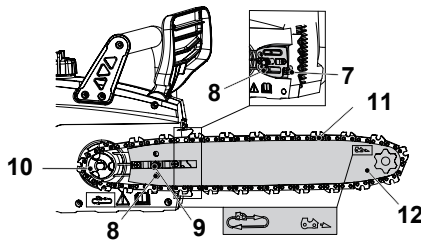

Fig. 3

- The saw chain movement is as indicated by the arrow. Make sure the saw chain (11) is properly placed over the sprocket wheel (12a) of the guide bar (12) (Fig. 4).

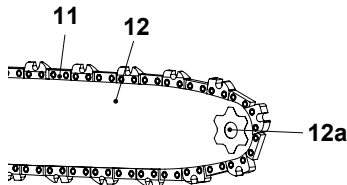

Fig. 4



WARNING! The direction of the saw chain 'cutters' must be as indicated by the symbol and arrow on the guide bar! Ensure the guide bar and saw chain are properly assembled in correct direction; otherwise the saw chain cannot work.

7. Screw the tension screw (7) clockwise out to adjust the tension pin (8) / guide bar (12) towards the right to tighten the saw chain (11) with a Multitool (25), then align and place the chain saw cover (14) over the mounting bolt (9) (Fig. 5).

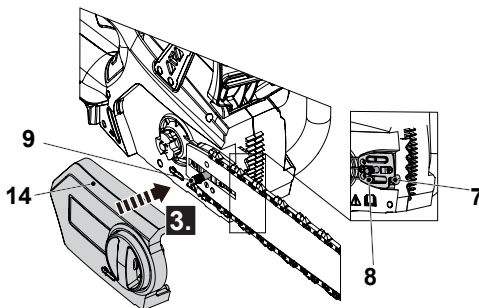

Fig. 5

8. Refit the chain saw cover (14) and slightly tighten the locking wheel (13) clockwise (Fig. 6). Ensure that the spigot (14a) engages correctly in the slot. Do not tighten the locking wheel (13) completely as saw chain tensioning is required first.

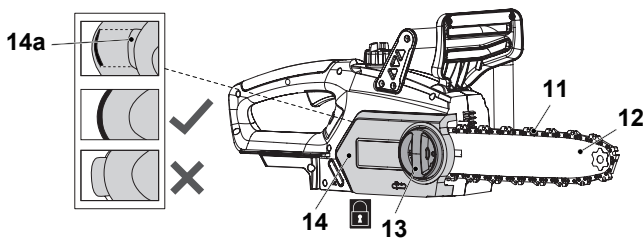

Fig. 6



NOTE: The saw chain (11) has not yet been tensioned. Tension the chain as described under "Saw chain tensioning". After operating the product for approx. 1 hour, adjust the chain tension again.

Saw chain tensioning

Always check the saw chain tension before use, after the first cuts and regularly during use, approx. every five cuts. Upon initial operation, new chains can lengthen considerably. This is normal during the break-in period and the interval between future adjustments will lengthen quickly.



WARNING! remove battery pack from product before adjusting saw chain tension!



The cutting edges of the saw chain are sharp! Always wear protective gloves when handling chain!



Always maintain proper chain tension! A loose chain increases the risk of kickback! A loose chain may jump out of the guide bar groove! This may injure the operator and damage the chain! A loose chain will cause rapid wear to the chain, guide bar and sprocket! Tensioning the chain too tightly will overload the motor and cause damage, and insufficient tension can cause chain derailing, whereas a correctly tightened chain provides the best cutting characteristics and prolonged working life! The chain life mainly depends upon sufficient lubrication and correct tensioning!

1. Place the product on a suitable flat surface with the chain saw cover (14) facing forwards.
2. Check the chain tension using one hand to lift the saw chain (11) against the weight of the product. The correct chain tension is achieved when the saw chain can be lifted by approximately 2 - 4 mm from the guide bar (12) in the centre (Fig.7, 8).

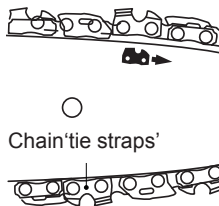

Fig. 7

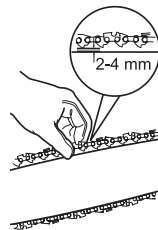

Fig. 8

3. Adjust the tension if you find that the saw chain (11) is too loose or tight.
4. Slightly loosen the locking wheel (13), then screw the tension screw (7) in or out to adjust the tension pin (8) / guide bar (12) towards the left or right until the chain 'tie straps' are just touching the bottom edge of the guide bar (12), hold it in the position.
5. Pull the saw chain (11) along the top of the guide bar (12) by gloved hand from one end to the other, several times. The saw chain (11) should feel tight but still move freely.
6. After the adjustment, re-tighten the locking wheel (13).

Chain lubrication



WARNING! The product is not filled with chain oil. It is essential to fill the product with chain oil before using it! Never operate the product without chain oil as this will result in extensive damage to the product!

Operating the saw chain dry or with too little chain oil will decrease cutting efficiency, shorten the product life span and cause rapid wear to the saw chain and guide bar from overheating!

Insufficient chain oil is evident by smoke or bar discoloration!

Adequate lubrication of the saw chain during cutting operations is essential to minimise friction with the guide bar!

1. Place the product on a stable, level surface with the oil tank cap (2) facing upward. We recommend laying a non-flammable sheet under the product.
2. Unscrew and remove the oil tank cap (2) (Fig. 9).

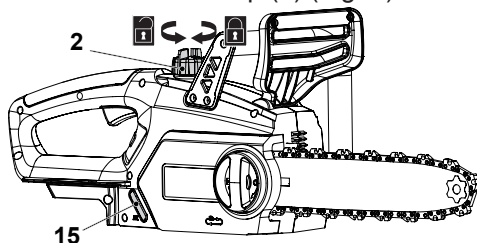

Fig.9

3. Fill suitable lubricant into the tank using an oil funnel fitted with a filter to avoid debris entering the tank. We recommend using environmentally friendly chain oil specially intended to be used with this product.



NOTE: In summer use SAE #30; in winter, or if the trees have excessive sap, use SAE #10.

4. Don't fill the oil lower than the oil level window (15), but also do not overfill or and leave approximately 5 mm of space between the top of the oil and the inside edge of the tank to allow for expansion (Fig. 10).

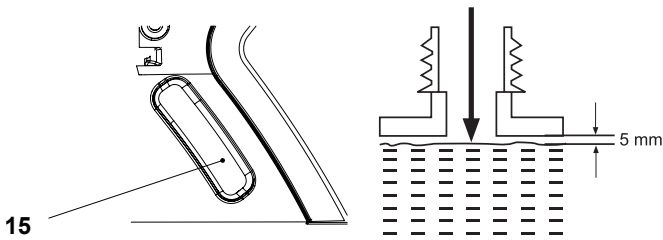

Fig. 10



NOTE: Towards the end of the season, it is advisable to put only as much lubricant in the tank as you need for each cut, so that it is completely used up before you store the product.

5. Check the oil level window (15) prior to start-up and regularly during operation. Refill oil when the oil level is close to the bottom of the oil level window (15) (Fig. 10).
6. Wipe up spilled lubricant with a soft cloth and refit the oil tank cap (2).



NOTE: Always dispose of lubricant, used oil and objects contaminated with them in accordance with local regulations.

Checking



NOTE: Perform the following test before operating your product. This product is equipped with an automatic oiling system. The oiling system automatically delivers the proper amount of oil to the bar and chain. Checking the lubrication requires starting the product. Before checking, the product must be fully assembled and all instructions must have been read.

1. Make sure the guide bar (12) and the saw chain (11) are in place when you check the oil delivery.
2. Start the product; keep it running at no load and check if the chain oil is delivered as shown in the figure (Figs.11, 12).

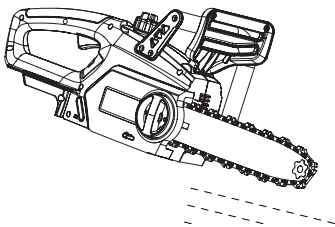

Fig. 11

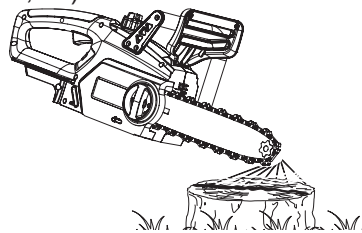

Fig. 12

Battery pack

Attaching / releasing the battery pack

1. Align the battery pack (23) with the sliding slots of the battery docking port (19) and slide the battery pack (23) in to attach it. Ensure it clicks in place (Fig. 13).
2. Press the release button (23b) and remove the battery pack (23) from the battery docking port (19) (Fig. 14).

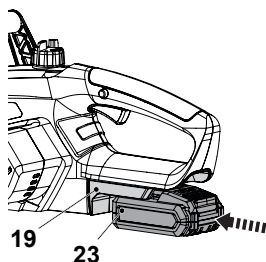

Fig. 13

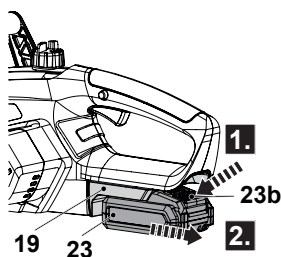

Fig. 14

Charging the battery pack

The battery pack (23) for this product has been shipped in a low charge condition. Charge it fully before first use.

Refer to the charger's instruction manual (MFC18) for the details.

Battery capacity indicators

The battery pack (23) is equipped with the battery capacity indicators (23c) which are used to give an indication of the battery pack's remaining capacity. Press the battery capacity button (23a) to check battery capacity (Fig. 15). The LEDs will stay lit for approximately 5 seconds.

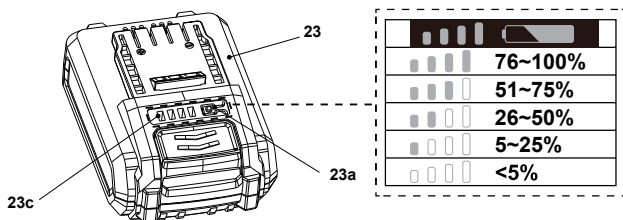

Fig. 15



In more detail...

Product functions	30
Operation	33
Care and maintenance	42
Troubleshooting	48
Recycling and disposal	49
Guarantee	50
Customer Care and Technical Helpline	52
Availability of Spare Parts	53
Technical specifications	54
Declaration of conformity	56

In more detail...

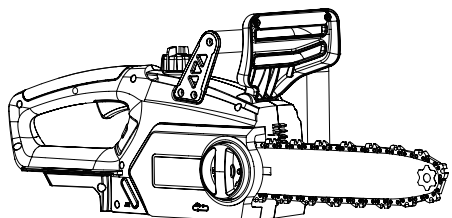

Intended use

This cordless chain saw MCS1825-Li is designated with a rated voltage of 18 V d.c. . It is designed only to be used with the battery pack which is listed in the chapter of “Technical specifications”.

The product is intended for cutting logs and limbs with a thickness of max. 25 cm.

It must not be used for cutting other materials, such as plastic, stone, metal, wood that contains foreign objects, or materials that are harmful to health.

This product should not be used outside of domestic premises e.g. for cutting firewood in forested areas.

The product may only be used with the guide bar/saw chain combination stated within these instructions. It is not permitted to use other types or sizes.

Vertical and horizontal cuts can be performed with this product. Longitudinal sections can only be cut by professionals.

This product should not be used outside of domestic premises e. g. for cutting firewood in forested areas.

The use of this product in case of rain or humid environment is prohibited.

For safety reasons it is essential to read the entire instruction manual before first operation and to observe all the instructions therein.

This product is intended for private domestic use only, not for any commercial trade use. It must not be used for any purposes other than those described.

Chain brake

The chain brake is a safety mechanism activated by the front safeguard (chain brake lever) (4). When kickback occurs the chain stops immediately.

Disengage chain brake: When the chain brake lever (4) is in the disengaged position, the product can be operated with running saw chain (Fig. 16).

Engage chain brake: When the chain brake lever (4) is in the engaged position, the saw chain is stopped as soon as the chain brake is activated (Fig. 17).

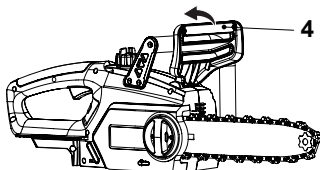

Fig. 16, disengage chain brake

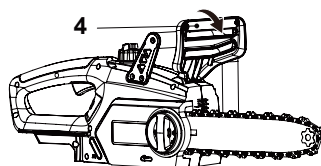

Fig. 17, Engage chain brake

Chain brake test



WARNING! Before operating this product, always check that the chain brake is in perfect working condition!

The following function check should be carried out before each use. The purpose of the chain brake testing is to reduce the possibility of injury due to kickback.

1. Make sure the chain brake is disengaged. Disengage the chain brake by pulling the front safeguard (chain brake lever) (4) back towards the front handle (3).
2. Place the product on any suitable flat surface, make sure the saw chain (11) is not touching the surface or other objects.
3. Attach the battery pack (23).
4. Hold the product with left hand on the front handle (3) and right hand on the rear handle (1) (Fig. 18).

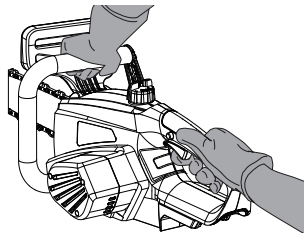

Fig. 18

5. Press the lock-off button (16), then squeeze the on/off switch (17) to switch the product on and wait until it runs at full speed.
6. While the motor is running, engage the chain brake by rolling your left hand forward against the front safeguard (chain brake lever) (4). The saw chain (11) should stop immediately.



WARNING! The motor will not start if the chain brake is in the engaged position.



WARNING! If the saw chain (11) and motor fail to stop when the chain brake is engaged, take the product to the nearest authorised service centre or a similarly qualified person! Do not use the product if the chain brake is not in working properly! The chain brake should not be used for starting and stopping the product during normal operation!

Overload protection

The overload protection may be activated in the following circumstances:

- If you work too quickly.
- Heavy cutting conditions.
- Where there is too much resistance against the saw chain.

This product features a battery protection, which cuts off the power when the product is overloaded.

1. Remove the product from the work piece to remedy the overload.
2. Let the product cool down for 15 - 30 minutes (until the battery temperature reduces to 65 - 75 °C) and eliminate the cause before using the product again.
3. Press the lock-off button (16), then squeeze the on/off switch (17) to restart the product. If the product is not switched on, replace / recharge the battery pack and repeat the action.

Low voltage protection

When the product fails to be switched on; or the product runs intermittently afterward, the battery pack may have been at low voltage level. Let the battery pack completely cool down and then recharge the battery pack.

On/off switch

1. Press the lock-off button (16) and hold it in position (Fig. 19, step 1).
2. Squeeze the on/off switch (17) to switch the product on (Fig. 19, step 2). Release the lock-off button afterward.
3. Release the on/off switch (17) to switch the product off.

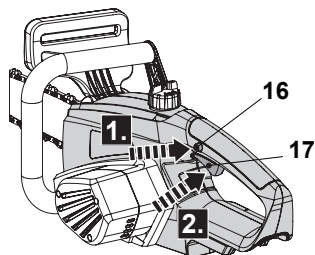

Fig.19



WARNING! The product will continue to work for some time even after the motor has been switched off! Wait until it comes to a complete stop before you put the product down!

General operation

1. Check the product, its battery pack and charger as well as accessories for damage before each use. Do not use the product if it is damaged or shows wear. Take care of any problem you find or have the product checked by qualified specialist.
2. Double check that the accessories and attachments are properly fixed.
3. Check the chain lubrication oil level regularly, refill if necessary.
4. Always hold the product on its handles. Keep the handles dry and free from lubricant to ensure safe support.
5. Ensure that the air vents are always unobstructed and clear. Clean them if necessary with a soft brush. Blocked air vents may lead to overheating and damage the product.
6. Switch the product off immediately if you are disturbed while working by other people entering the working area. Always let the product come to complete stop before putting it down.
7. Do not overwork yourself. Take regular breaks to ensure you can concentrate on the work and have full control over the product.
8. Before switching the product on, check whether it has been assembled correctly and all the moving parts are running smoothly!
9. While working, ensure that the product does not strike hard objects, as this can cause damage.



WARNING! In some countries regulations define at what time of the day and on what special days products are allowed to be used and what restrictions apply! Ask your community for detailed information and observe the regulations in order to preserve a peaceful neighbourhood and avoid committing administrative offences!

Basic operating / cutting procedure



WARNING! Chainsaws by their very nature are extremely dangerous machines and should be handled with respect! We strongly recommend that before use of this product, you attend a chainsaw training course to familiarise yourself with the maintenance and usage of these products! Thoroughly read this manual and adhere to all safety instructions at all times. Manufacturer will not be held liable for any accidents / injuries caused due to misuse or incorrect maintenance of this product!

1. To become proficient attend a recognised chain saw training course to learn how to operate chain saws safely and effectively. Familiarise yourself with all the controls and switches. Practise all movements with the product switched off.
2. Always hold the product firmly with both hands; front handle (3) with the left hand and rear handle (1) with the right hand. Fully grip both handles at all times during operation. Never operate the product using only one hand.
3. Only use the product with a secure stance. Hold the product at the right-hand side of your body (Fig. 20).

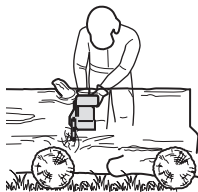

Fig. 20

4. Check the proper lubrication as described in section “Assembly-Chain lubrication” before performing any cut.
5. Ensure the saw chain (11) is running at full speed before it makes contact with the wood. Use spiked bumper (5) to secure the product onto the wood before starting to cut and use it as a leverage point while cutting (Fig. 21).

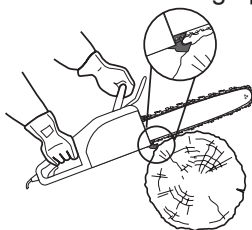

Fig. 21

6. Reset the spiked bumper (5) at a low point when cutting thicker logs by pulling the product slightly backwards until the gripping teeth release, and reposition at lower level to continue sawing. Do not remove the product completely from the wood.
7. Do not force the saw chain while cutting, let the chain do the work, using the gripping teeth to apply minimal leverage pressure.
8. Do not operate the product with arms fully extended or attempt to saw areas which are difficult to reach, or on a ladder. Never use the product above shoulder height (Fig. 22).

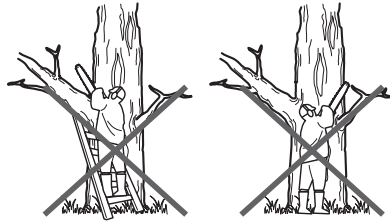

Fig. 22

9. Optimum sawing is achieved if the chain speed remains constant during cutting.
10. Be careful when reaching the end of the cut. The weight of the product may change unexpectedly as it cuts free from the wood. This can cause accidents to the legs and feet. Always remove the product from a wood cut while the product is running.
11. Check that the oil feed to the chain is operating correctly; run the chain saw at medium speed and ensure that the chain has received a consistent coating of oil.

Kickback



WARNING! Beware of kickback! Kickback can lead to dangerous loss of control of the product and result in serious or fatal injury to the operator or anyone standing close by! Always be alert because rotational kickback and pinch kickback are major product operational dangers and the leading cause of most accidents!



Kickback may occur when the nose or tip of the guide bar touches an object, or when wood pinches the saw chain in the cut.

In some cases, contact with the tip of the guide bar (12) may cause a lightning-fast reverse reaction, kicking the guide bar up and back toward the operator (Figs. 23, 24, 25).

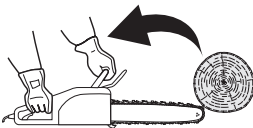

Fig. 23

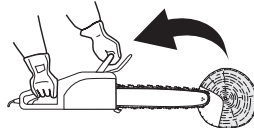

Fig. 24

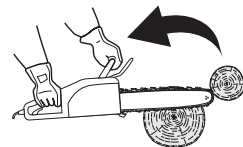

Fig. 25

1. Pinching the saw chain (11) along the bottom of the guide bar (12) may pull the product forward away from the operator (Fig. 26).
2. Pinching the saw chain (11) along the top of the guide bar (12) may push the guide bar rapidly back toward the operator (Fig. 27).

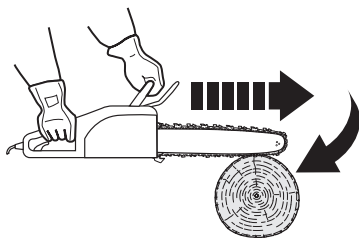

Fig. 26

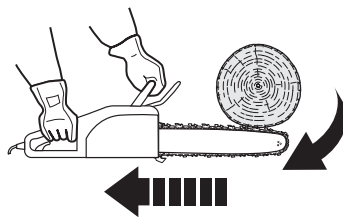

Fig. 27

3. Any of these reactions may cause loss of control of the product, which could result in serious personal injury or even death.
4. With a basic understanding of 'kickback', the element of surprise can be reduced or eliminated. Sudden surprise contributes to the majority of accidents.
5. Keep a good firm grip on the product with both hands, the right hand on the rear handle (1) and the left hand on the front handle (3), when the motor is running. Maintain a firm grip with your thumbs and fingers encircling the product handles (1, 3). A firm grip will help you reduce 'kickback' and maintain control of the product.
6. You should carefully read all safety warnings and user instructions carefully before attempting to operate this product.

To avoid kickback:

1. Saw with guide bar at a flat angle.
2. Never work with a loose, widely stretched or the heavily worn out chain.
3. Ensure chain is sharpened correctly.
4. Never saw above shoulder height.
5. Never work with the tip of the guide bar.
6. Always hold the product firmly with both hands.
7. Always use a low kickback chain.
8. Apply the metal gripping teeth for leverage the work piece.
9. Ensure correct chain tension.
10. Do only cut with the motor at high speeds.
11. Do not let the nose of the guide bar contact a log, branch, or any other obstruction which could be hit while you are operating the product.
12. Follow manufacturer's sharpening and maintenance instructions for the saw chain.
13. Only use replacement guide bars and saw chains specified by the manufacturer or equivalent replacements.



WARNING! Most 'kickback' accidents happen during limbing! Pay close attention to the position of the 'kickback' zone of the bar when you are 'limbing' branches that are under tension!



Felling a tree



WARNING! Before commencing work or attempting to fell any tree, check with your Local Council to ensure you have permission! Even in your own garden you may be in a conservation area, the tree you wish to fell may have a conservation order against it or the tree may be visible on the plans of your house – In all these instances and more, you may be required to obtain permission before work can begin!

1. When bucking and felling operations are being performed by two or more persons at the same time, the felling operations should be separated from the bucking operation by a distance of at least twice the height of the tree being felled. Trees should not be felled in a manner that would endanger any person, strike any utility line or cause any property damage. If the tree does make contact with any utility line, the company should be notified immediately.
2. The product operator should keep on the uphill side of the terrain as the tree is likely to roll or slide downhill after it is felled.
3. An escape path should be planned and cleared as necessary before cuts are started. The escape path should extend back and diagonally to the rear of the expected line of fall (Fig. 28).

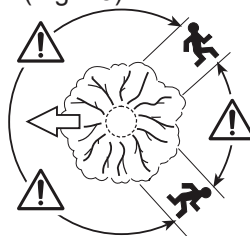

Fig. 28

4. Before felling is started, consider the natural lean of the tree, the location of larger branches and the wind direction to judge which way the tree will fall.
5. Remove dirt, stones, loose bark, nails, staples and wire from the tree.

Notching undercut

Make the notch (Fig. 29, B) 1/3 the diameter of the tree, perpendicular to the direction of falls (Fig. 29). Make the lower horizontal notching cut first. This will help to avoid pinching either the saw chain or the guide bar when the second notch is being made.

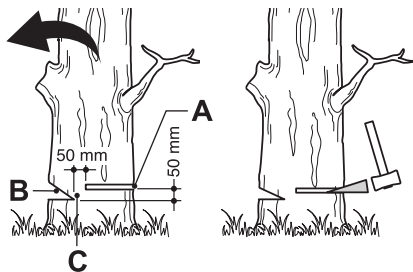

Fig. 29

Felling back cut

1. Make the felling back cut (Fig. 29, A) at least 50 mm higher than the horizontal notching cut (Fig. 29). Keep the felling back cut parallel to the horizontal notching cut. Make the felling back cut so enough wood is left to act as a hinge. The hinge wood (Fig. 29, C) keeps the tree from twisting and falling in the wrong direction. Do not cut through the hinge.
2. As the felling gets close to the hinge, the tree should begin to fall. If there is any chance that the tree may not fall in desired direction or it may rock back and bind the saw chain, stop cutting before the felling back cut is complete and use wedges of wood, plastic or aluminium to open the cut and drop the tree along the desired line of fall.
3. When the tree begins to fall remove the product from the cut, stop the motor, put the product down, and then use the retreat path planned. Be alert for overhead limbs falling and watch your footing.

Limbing and pruning

Limbing is removing the branches from a fallen tree. When limbing leave larger lower limbs to support the log off the ground. Remove the small limbs in one cut (Fig. 30). Branches under tension should be cut from the bottom up to avoid binding the product.

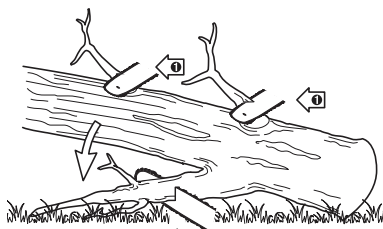

Fig. 30



WARNING! Never climb into a tree to limb or prune! Do not stand on ladders, platforms, logs, or in any position which may cause you to lose the balance or control of the saw! When pruning trees, it is important not to make the flush cut next to main limb or trunk until you have cut off the limb further out to reduce the weight! This prevents stripping the bark from the main member!



WARNING! If the limbs to be pruned are above chest height, hire a professional to perform the pruning!

Cutting spring poles

A spring pole is any log, branch, rooted stump, or sapling which is bent under tension by other wood so that it springs back if the wood holding it is cut or removed (Fig. 31).

On a fallen tree, a rooted stump has a high potential of springing back to the upright position during the bucking cut to separate the log from the stump. Watch out for spring poles, they are dangerous.



Fig. 31

Bucking a log

Bucking or cross-cutting is cutting a log into lengths. It is important to make sure your footing is firm and your weight is evenly distributed on both feet. When possible, the log should be raised and supported by the use of limbs, logs or chocks.

1. Follow the simple directions for easy cutting. When the log is supported along its entire length (Fig. 32), it is cut from the top (overbuck).

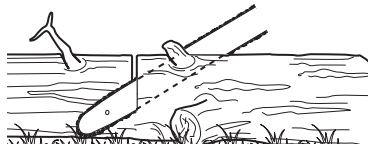

Fig. 32

2. When the log is supported on one end (Fig. 33), cut 1/3 the diameter from the underside (underbuck). Then make the finished cut by overbucking to meet the first cut.

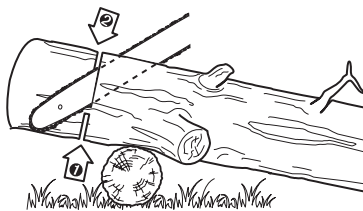

Fig. 33

- When the log is supported on both ends (Fig. 34), cut 1/3 the diameter from the top (overbuck). Then make the finished cut by underbucking the lower 2/3 to meet the first cut.

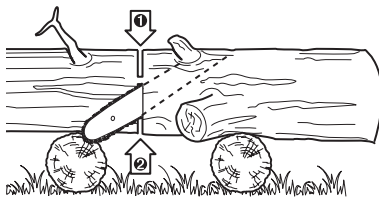

Fig. 34

- When bucking on a slope always stand on the uphill side of the log (Fig. 35). When "cutting through", to maintain complete control release the cutting pressure near the end of the cut without relaxing your grip on the product handles. Don't let the chain contact the ground. After completing the cut, wait for the saw chain to stop before you move the product. Always stop the motor before moving from tree to tree.



Fig. 35

- Support small logs on a sawing stand or another log while bucking (Fig. 36).

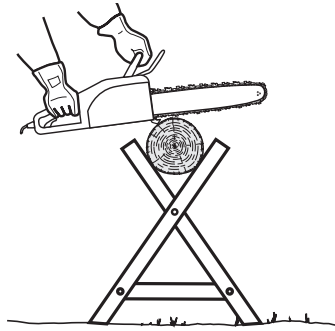

Fig. 36

6. If the wood diameter is large enough for you to insert a soft bucking wedge without touching the chain, you should use the wedge to hold the cut open to prevent pinching (Fig. 37).

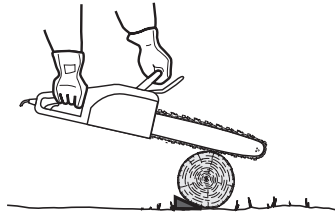

Fig. 37

After use

1. Switch the product off, remove the battery pack and let it cool down.
2. Attach the guide bar cover (22) to the saw chain (11) if necessary.
3. Check, clean and store the product as described below.

The golden rules for care



WARNING! Always switch the product off, remove the battery pack (23) and let the product cool down before performing inspection, maintenance and cleaning work!

1. Keep the product clean. Remove debris from it after each use and before storage.
2. Regular and proper cleaning will help ensure safe use and prolong the life of the product.
3. Inspect the product before each use for worn and damaged parts. Do not

operate it if you find broken and worn parts.



WARNING! Only perform repairs and maintenance work according to these instructions! All further works must be performed by a qualified specialist!

General Cleaning

1. Clean the product with a damp cloth and pH-neutral soap. Use a brush for areas that are hard to reach.
2. In particular clean the air vents (21) after every use with a cloth and brush.
3. Remove stubborn dust with high pressure air (max. 3 bar).



NOTE: Do not use chemical, alkaline, abrasive or other aggressive detergents or disinfectants to clean this product as they might be harmful to its surfaces.

4. Check for any damage and wear. Repair damages in accordance with this instruction manual or take it to an authorised service centre before using the product again.

Sprocket wheel



NOTE: It is not necessary to remove the saw chain (11) to lubricate the sprocket wheel (12a). Lubrication can be done on the job.

1. Clean the sprocket wheel (12a).
2. Using a disposable lube gun, insert the needle nose into the lubrication hole (12b) (Fig. 38) and inject grease until it appears at the outside edge of the sprocket wheel (12a).
- 3.

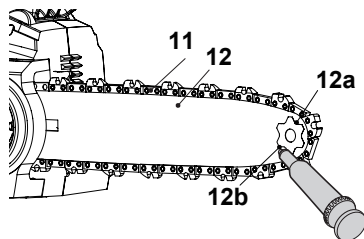

Fig. 38

4. Rotate the saw chain (11) by hand. Repeat the lubrication procedure until the entire sprocket wheel (12a) has been greased.

Guide bar and saw chain maintenance

Guide bar

Most guide bar problems can be prevented merely by keeping the product well maintained. Incorrect filling and non-standard cutter and depth gauge settings are the causes of most guide bar problems, primarily resulting in uneven bar wear. As the bar wears unevenly, the rails widen, which may cause the chain to clatter and make it difficult to complete straight cuts. If the guide bar is insufficiently lubricated and the product is operated with a saw chain which is too tight, this will contribute to rapid bar wear. To help minimise bar wear, maintenance of the guide bar as well as the saw chain is recommended.

1. Disassemble the guide bar (12) and saw chain (11) in reversed order from assembly.
2. Check the oiling port (6) for clogging and clean if necessary to ensure proper lubrication of the guide bar and saw chain during operation. Use a soft wire small enough to insert into the oil discharge hole (Fig. 39).

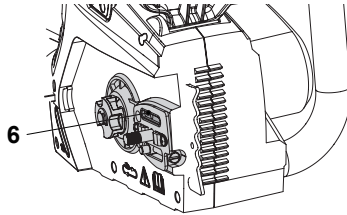

Fig. 39



NOTE: The condition of the oil passages can be easily checked. If the passages are clear, the chain will automatically give off a spray of oil within seconds of the product starting. Your product is equipped with an automatic oiling system.

3. Check the drive sprocket (10). If it is worn or damaged due to strain, have it replaced by an authorised service agent or a similarly qualified person.
4. Clear residue from the rails on the guide bar (12) by using a screwdriver, putty knife, wire brush or other similar tool. This will keep the oil passages open to provide proper lubrication to the guide bar (12) and saw chain (11) (Fig. 40).

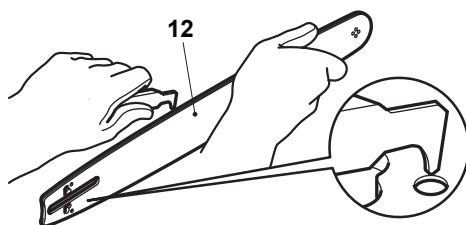

Fig. 40

5. Check the guide bar 'rail' for wear: Hold a ruler (straight edge) against the side of the guide bar and 'cutter side plates'. If there is a gap between the ruler and guide bar the guide bar 'rail' is normal. If there is no gap (ruler flush against the side of the guide bar) the guide bar 'rail' is worn and needs to be replaced with a new one of the same type (Fig. 41).

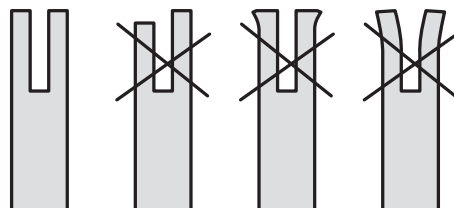

Fig. 41

6. Turn the guide bar 180° to allow even wear, thereby extending the life span of the guide bar (12).
7. Check the saw chain for possible wear and damages. Replace it with a new one if required. Experienced user can sharpen a dull saw chain (see section "Saw chain sharpening" below).
8. Refit the saw chain (11) and the guide bar (12) as described under "Assembly".

Saw chain sharpening



NOTE: Never saw with a blunt chain. The saw chain is blunt if you have to push the product into the tree and the chips are very small.

1. Have the saw chain (11) sharpened professionally at an authorised service centre or sharpen the chain yourself by using a proper sharpening kit. Also observe the sharpening instructions supplied with the sharpening kit.



WARNING! Only sharpen the saw chain yourself if you are trained and have experience! Use proper tools to sharpen the saw chain!

2. The height difference between the tooth and the ridge is the cutting depth. When sharpening the saw chain (11) you have to consider the following points (Fig. 42).
 - File angle
 - Cutting angle
 - File position
 - Diameter of round file
 - File depth

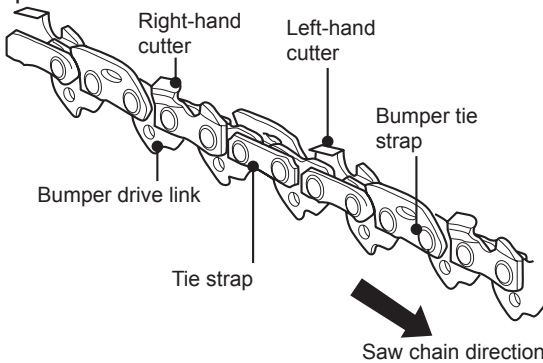

Fig. 42

3. To sharpen the chain proceed as follows:
 - Use protective gloves.
 - Ensure the chain is correctly tensioned.
 - Engage the chain brake to lock the chain on the bar.
4. Use a chain file, whose diameter is 1.1 times the cutting tooth depth. Make sure 20 % of the file diameter is above the cutter's top plate.



NOTE: A file guide is available from most reputable tool merchants and is the easiest way to hold the file at the correct position.

5. File at an angle perpendicular to the bar, and at an angle of 25° to the direction of travel (Fig. 43).

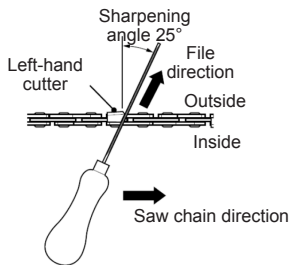

Fig. 43

6. File each tooth from the inside towards outside only. File one side of the chain first than turn the saw around and repeat the process.
7. Sharpen each tooth equally by using the same number of strokes.
8. Keep all cutter lengths equal. Check the safety depth gauge height every 5 sharpenings. If the depth gauges are also trimmed it is essential that the original profile be restored.
9. Use a depth gauge measuring instrument to check the height of the depth gauge. Depth gauge measuring jigs are available from most reputable tool merchants (Fig. 44).

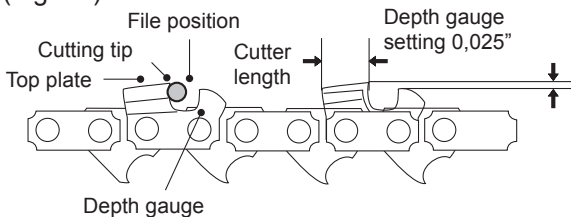

Fig. 44

Repair

This product does not contain any parts that can be repaired by the consumer. Contact an authorised service centre or a similarly qualified person to have it checked and repaired.

Storage

1. Switch the product off and remove the battery pack.
2. Clean the product as described above.
3. Attach the guide bar cover (22) to the saw chain (11) if necessary.
4. Store the product and its accessories in a dark, dry, frost-free, well-ventilated place.
5. Always store the product in a place that is inaccessible to children. The

ideal storage temperature is between 10 °C and 30 °C.

6. We recommend using the original package for storage or covering the product with a suitable cloth or enclosure to protect it against dust.
7. Charge the battery pack (23) before storage.
8. Empty the oil tank if you are not going to use the product for an extended period of time (more than 3 months) and before storing it for the winter.

Transportation

1. Switch the product off remove the battery pack.
2. Attach the guide bar cover (22) to the saw chain (11) if necessary.
3. Always carry the product by its handles (1, 3).
4. Protect the product from any heavy impact or strong vibrations which may occur during transportation in vehicles.
5. Secure the product to prevent it from slipping or falling over.

Troubleshooting

Suspected malfunctions are often due to causes that the users can fix themselves. Therefore check the product using this section. In most cases the problem can be solved quickly.



WARNING! Only perform the steps described within these instructions! All further inspection, maintenance and repair work must be performed by an authorised service centre or a similarly qualified specialist if you cannot solve the problem yourself!

Problem	Possible cause	Solution
1. Product does not start	1.1 Battery pack is not properly attached	1.1 Attach properly
	1.2 Battery pack is discharged	1.2 Remove and charge battery pack
	1.3 Battery pack is hot	1.3 Remove and let it cool
	1.4 Battery pack is damaged	1.4 Check by a specialist electrician
	1.5 Chain brake is activated	1.5 Disengage the chain brake
	1.6 Other electrical defect to the product	1.6 Check by a specialist electrician
2. Product does not reach full power	2.1 Battery pack capacity is too low	2.1 Charge battery pack
	2.2 Air vents are blocked	2.2 Clean the air vents
3. Unsatisfactory result	3.1 Saw chain not tensioned properly	3.1 Tension properly
	3.2 Saw chain is dull/damaged	3.2 Sharpen or replace the saw chain
	3.3 Chain oil tank is empty	3.3 Refill the chain oil
4. Product suddenly stops	4.1 Battery pack is discharged	4.1 Remove and charge battery pack
	4.2 Battery pack is too hot	4.2 Remove battery pack and let it cool down
	4.3 Saw chain is blocked	4.3 Remove blockage
5. Excessive vibration or noise	5.1 Saw chain is dull/damaged	5.1 Replace with a new one
	5.2 Bolts/nuts are loosen	5.2 Tighten bolts/nuts
	5.3 Chain oil is incorrect	5.3 Drain out unused oil and refill with correct oil

Recycling and disposal



Waste electrical products should not be disposed of with household waste. Please recycle where facilities exist. Check with your Local Authority or local store for recycling advice.

For further information visit www.recycle-more.co.uk.

The product comes in a package that protects it against damage during shipping. Keep the package until you are sure that all parts have been delivered and the product is working properly. Recycle the package afterwards.

Disposal of an exhausted battery pack



The battery is Li-Ion type. To preserve natural resources, please recycle or dispose of the battery pack properly. Consult your local waste authority for information regarding available recycling and / or disposal options.

Discharge your battery pack by operating your tool, then remove the battery pack from the tool and cover the battery pack connections with heavy duty adhesive tape to prevent short circuit and energy discharge.

Do not attempt to open or remove any of the components.

Guarantee

We take special care to select high quality materials and use manufacturing techniques that allow us to create products incorporating design and durability. This product has a manufacturer's guarantee of 2 years against manufacturing defects, from the date of purchase (if bought in store) or date of delivery (if bought online), at no additional cost for normal (non-professional or commercial) household use.

To make a claim under this guarantee, you must present your proof of purchase (such as a sales receipt, purchase invoice or other evidence admissible under applicable law), please keep your proof of purchase in a safe place. For this guarantee to apply, the product you purchased must be new, it will not apply to second hand or display products. Unless stated otherwise by applicable law, any replacement product issued under this guarantee will only be guaranteed until expiry of the original period guarantee period.

This guarantee covers product failures and malfunctions provided the product was used for the purpose for which it is intended and subject to installation, cleaning, care and maintenance in accordance with the information contained in these terms and conditions, in the user manual and standard practice, provided that standard practice does not conflict with the user manual.

This guarantee does not cover defects and damage caused by normal wear and tear or damage that could be the result of improper use, faulty installation or assembly, neglect, accident, misuse, or modification of the product. Unless stated otherwise by applicable law, this guarantee will not cover, in any case, ancillary costs (shipping, movement, costs of uninstalling and reinstalling, labour etc), or direct and indirect damage.

Rights under this guarantee are enforceable in the country in which you purchased this product. Guarantee related queries should be addressed to the store you purchased this product from.

The guarantee is in addition to and does not affect your statutory rights.

Manufacturer:

Kingfisher International Products Limited
3 Sheldon Square, W26PX London United Kingdom
www.kingfisher.com/products

Distributor:

B&Q plc
Chandlers Ford, Hants, SO53 3LE, United Kingdom

www.diy.com

Screwfix Direct Limited
Trade House, Mead Avenue, Yeovil, BA22 8RT, United Kingdom
www.screwfix.com

In more detail...





Customer Care and Technical Helpline

A better way to repair your tools

Kingfisher takes special care in creating high-quality garden power tools that are designed to last. But if a fault develops with your garden power tool and you need to claim under the guarantee, the Customer Care and Technical Helpline can support with technical assistance or if required, arrange a free courier collection from your home, assess your garden power tool for fault, repair it, and return it.

Deciding to repair your product rather than buying a replacement and adding to the mountain of waste is a more sustainable choice and you will be doing your bit for the environment.

How does it work?

				
Step 1 Find your proof of purchase and get in touch with the Customer Care and Technical Helpline.	Step 2 Chat to them about the problem with your tool.	Step 3 They will provide technical and user advice or alternatively arrange a courier collection from your	Step 4 The team will assess and test and if necessary, repair your product back to full working order.	Step 5 Your repaired tool will be returned to you via courier within 5 working days*.



NOTE: before collection, all fuel must be removed from petrol powered machines

Get in touch

If you need help or more information, please contact the Customer Care and Technical Helpline:

UK: 0800 0789647

Eire: 1800 932226

Opening hours are Monday – Friday, 8am-5pm

Availability of Spare Parts

Contact the customer service helpline for assistance or visit www.kingfisherspares.com

For assistance contact the customer services helpline:
UK 0800 0789647 uk@Kingfisherservice.com
EIRE 1800 932226 eire@kingfisherservice.com

Further information about this product can also be found at:
www.kingfisher.com/products

Technical specifications

General

>Rated voltage	:18V 
>Rated no load speed n_0	:2400 min ⁻¹
>Oil tank volume	:230 cm ³ (ml)
>Weight	:approx. 3.5 kg
>Dimensions	:approx. 62.5*20.5*24 cm

Saw chain and guide bar

>Saw chain type	:90PX040X Oregon
>Guide bar type	:104MLEA041 Oregon
>Guide bar length	:254 mm (10")
>Max. cutting length	:25 cm
>Chain pitch	:9.525 mm (0.375")
>Chain gauge	:1.1 mm (0.043")
>Drive sprocket	:6 teeth x 30 mm
>Max. chain speed	:4.5 m/s

Battery pack

>Model no	:TTI803BAT
>Type	:Li-Ion, 5 x 3.6 V 
>Capacity	:5000 mAh
>Voltage	:18 V 
>Weight	:approx. 0.69 kg



Charger for battery pack

>Model no	:TTB805CHR
>Rated output	:21.4 V  , 4 A

Usable battery pack (sold separately) :

>Model no	:TTI802BAT	TTB812BAT
>Capacity	:4000 mAh	8000 mAh

Usable charger (sold separately) :

>Model no	:TTB804CHR	TTB815CHR
>Rated output	:21.4 V  , 2.4 A	21 V  , 8 A
>Ambient temperature range for charger and battery use : 5°C to 40°C		

Sound values

>Sound pressure level L_{pA}	:85 dB(A)
>Uncertainty K_{pA}	:3 dB(A)
>Measured sound power level L_{WA}	:96 dB(A)
>Uncertainty K_{WA}	:3 dB(A)

>Guaranteed sound power level L_{WA} :99 dB(A)
 (according to 2000/14/EC amended by
 2005/88/EC)

Hand arm vibration values

>Front handle a_h :4.1 m/s²
>Rear handle a_h :2.5 m/s²
>Uncertainty K :1.5 m/s²

The sound emission values and noise emission value(s) have been obtained according to the noise test code given in EN 62841-1 and EN 62841-4-1 using the basic standards EN ISO 12101 and EN ISO 3744.

The noise and noise emission value(s) for the operator may exceed 80 dB(A) and ear protection measures are necessary.

The declared vibration total value(s) and the declared noise emission value(s) have been measured in accordance with a standard test method and may be used for comparing one tool with another;

The declared vibration total value(s) and the declared noise emission value(s) may also be used in a preliminary assessment of exposure.



WARNING! The vibration and noise emissions during actual use of the power tool can differ from the declared values depending on the ways in which the tool is used especially what kind of workpiece is processed; and need to identify safety measures to protect the operator that are based on an estimation of exposure in the actual conditions of use (taking account of all parts of the operating cycle such as the times when the tool is switched off and when it is running idle in addition to the trigger time).

Rating label explanation

Chain saw: TTI932CHN

TTI= TITAN Brand
 932=Series number
 CHN=Chain saw

Battery pack: TTI803BAT

TTI= TITAN Brand
 803=Series number
 BAT= Battery pack

Charger: TTB805CHR

TTB=TITAN Brand
 805=Series number
 CHR=Charger

Declaration of conformity



(UK) DECLARATION OF CONFORMITY

Product

- Cordless Chainsaw 18V 25cm
- TTI932CHN
- Type / batch or serial number range 000001 to 999999

Name and address of the manufacturer or his authorised representative:

Kingfisher International Products Limited
3 Sheldon Square
London W2 6PX
United Kingdom

This declaration of conformity is issued under the sole responsibility of the manufacturer.

Object of the declaration

Product	Model	EAN
Cordless Chainsaw 18V 25cm	TTI932CHN	5059340370187

The object of the declaration described above is in conformity with the relevant legislation:

Supply of Machinery (Safety) Regulations 2008 as amended
Noise Emission in the Environment by Equipment for Use Outdoors Regulations 2001 as amended
Electromagnetic Compatibility Regulations 2016 as amended
The Restriction of the use of Certain Hazardous Substances in Electrical and Electronic Equipment Regulations 2012 as amended

Measured Sound Power Level: 96 dB(A)
Guaranteed Sound Power Level: 99 dB(A)

References to the relevant designated standards used or references to the other technical specifications in relation to which conformity is declared:

EN 62841-1:2015
EN 62841-4-1:2020
EN IEC 55014-1:2021
EN IEC 55014-2:2021
EN ISO 3744:1995

Authorised signatory and technical file holder:
Kingfisher International Products Limited
3 Sheldon Square
London W2 6PX
United Kingdom

David Awe
Group Quality Director

On [20/04/2022]



(EN) EU DECLARATION OF CONFORMITY
 (FR) DÉCLARATION UE DE CONFORMITÉ
 (PL) DEKLARACJA ZGODNOŚCI UE
 (RO) DECLARAȚIA DE CONFORMITATE UE
 (ES) DECLARACIÓN UE DE CONFORMIDAD
 (PT) DECLARAÇÃO DE CONFORMIDADE UE

Product/ Produit/ Produkt/Produsul/Producto/Produto

- Cordless Chainsaw 18V 25cm/ Tronçonneuse sur batterie 18V 25cm/ Pilarka łańcuchowa bezprzewodowa 18V 25cm/ Motofierăstrău fără fir 18V 25cm/ Motosierra sin cable de 18V 25cm/ Motosserra sem fios de 18V 25cm/ Kablosuz motorlu testere 18V 25cm
- TTI932CHN
- Type / batch or serial number range 000001 to 999999

Name and address of the manufacturer or his authorised representative:

Nom et adresse du fabricant ou de son mandataire:

Nazwa i adres producenta lub jego upoważnionego przedstawiciela:

Denumirea și adresa producătorului sau a reprezentantului său autorizat:

Nombre y dirección del fabricante o de su representante autorizado:

Nome e endereço do fabricante ou do respetivo mandatário:

Kingfisher International Products B.V.,
 Rapenburgerstraat 175E,
 1011 VM Amsterdam,
 The Netherlands

This declaration of conformity is issued under the sole responsibility of the manufacturer.

La présente déclaration de conformité est établie sous la seule responsabilité du fabricant.

Niniejsza deklaracja zgodności wydana zostaje na wyłączną odpowiedzialność producenta.

Prezenta declarație de conformitate este emisă pe răspunderea exclusivă a producătorului.

La presente declaración de conformidad se expide bajo la exclusiva responsabilidad del fabricante.

A presente declaração de conformidade é emitida sob a exclusiva responsabilidade do fabricante.

Object of the declaration/Objet de la declaration/Przedmiot deklaracji/Obiectul declarației/Objeto de la declaración/Objeto da declaração

Product/Produit/Produkt/Produsul/Producto/Produto

Model/Modèle/Model/Modelul/Modelo/ Modelo

EAN

Cordless Chainsaw 18V 25cm/
 Tronçonneuse sur batterie
 18V 25cm/ Pilarka łańcuchowa
 bezprzewodowa 18V 25cm/
 Motofierăstrău fără fir 18V 25cm/
 Motosierra sin cable de 18V 25cm/
 Motosserra sem fios de 18V 25cm/
 Kablosuz motorlu testere 18V 25cm

TTI932CHN

5059340370187 (UK)
 5059340370248 (EU)

The object of the declaration described above is in conformity with the relevant Union harmonisation legislation:

L'objet de la déclaration décrit ci-dessus est conforme à la législation d'harmonisation de l'Union applicable:

Wymieniony powyżej przedmiot niniejszej deklaracji jest zgodny z odpowiednimi wymaganiami unijnego

prawodawstwa harmonizacyjnego:

Obiectul declarației descris mai sus este în conformitate cu legislația relevantă de armonizare a Uniunii:

El objeto de la declaración descrita anteriormente es conforme con la legislación de armonización pertinente de la Unión:

O objeto da declaração acima descrito está em conformidade com a legislação de harmonização da União aplicável:

In more detail...

2006/42/EC as amended	Machinery Directive
2014/30/EU as amended	Directive Electromagnetic compatibility
2000/14/EC as amended	Outdoor Noise Directive
2011/65/EU as amended	Directive Restriction of the use of certain hazardous substances in electrical and electronic equipment
Directive 2006/42/CE relative aux machines	
2014/30 / UE telle que modifiée Directive Compatibilit�� electromagn��tique	
Directive 2000/14/CE relative aux ��missions sonores ext��rieures	
Directive 2011/65/UE relative �� la limitation de l'utilisation de certaines substances dangereuses dans les ��quipements ��lectriques et ��lectroniques	
2006/42/WE w zmienionej dyrektywie maszynowej	
2014/30 / UE ze zmianami Dyrektywa Kompatybilno�� elektromagnetyczna	
2000/14/WE w zmienionej dyrektywie w sprawie ha��su na zewn��trz	
2011/65 / UE ze zmianami Dyrektywa Ograniczenie stosowania ni��kt��rych niebezpiecznych substancji w sprz��cie elektrycznym i elektronicznym	
2006/42/CE, astfel a fost modificat�� Directiva privind echipamentele	
2014/30/UE, astfel a fost modificat�� Directiva privind compatibilitatea electromagnetice	
2000/14/CE, astfel a fost modificat�� Directiva privind zgomotul ��n aer liber	
2011/65/UE, astfel a fost modificat�� Directiva privind limitarea utiliz��rii anumitor substan��e periculoase ��n echipamentele electrice �� electronice	
Directiva sobre maquinaria modificada 2006/42/CE	
2014/30/UE modificada Directiva Compatibilitad electromagn��tica	
2000/14/CE modificada Directiva sobre ruido al aire libre	
2011/65/UE modificada Directiva Restricci��n del uso de determinadas sustancias peligrosas en equipos el��ctricos y electr��nicos	
2006/42/CE como diretiva de m��quinas alteradas	
2014/30/UE, astfel a fost modificat�� Directiva privind compatibilitatea electromagnetice	
2000/14/CE como diretiva de ru��do exterior alterada	
2011/65/UE como restri��c��o diretiva alterada da utiliza��o de certas subst��ncias perigosas em equipamentos el��tricos e eletr��nicos	

Measured Sound Power Level

Le niveau de puissance acoustique mesur  
 Zmierzony poziom mocy akustycznej
 Nivel de putere acustic   m  surat
 Nivel de potencia sonora medido
 Nivel de pot  ncia sonora medido
 : 96 dB(A)

Guaranteed Sound Power Level

Le niveau de puissance acoustique garant
 Gwarantowany poziom mocy akustycznej
 Nivel de putere acustic   garantat
 Nivel de potencia sonora garantizado
 Nivel de pot  ncia sonora garantido
 : 99 dB(A)

References to the relevant harmonised standards used or references to the other technical specifications in relation to which conformity is declared:

R  f  rences des normes harmonis  es pertinentes appliqu  es, y compris la date de celles-ci, ou des autres specifications techniques, y compris la date de celles-ci, par rapport auxquelles la conformit   est d  clar  e:

Odwolania do odno  nych norm zharmonizowanych, kt  re zastosowano, wraz z dat   normy, lub do innych specyfikacji technicznych, wraz z dat   specyfikacji, w odniesieniu do kt  rych deklarowana jest zgodno  :

Trimiteri la standardele armonizate relevante folosite, inclusiv data standardului, sau trimiteri la celelalte specificaii tehnice, inclusiv data specificaiiilor,   n leg  tur   cu care se declar   conformitatea:

Referencias a las normas armonizadas pertinentes utilizadas, incluidas las fechas de las normas, o referencias a las otras especificaciones t  cnicas, incluidas las fechas de las especificaciones, respecto a las cuales se declara la conformidad:

Refer  ncias   s normas harmonizadas aplic  veis utilizadas, incluindo a data da norma, ou   s outras especifica  es t  cnicas, incluindo a data da especifica  o, em rela  o   s quais    declarada a conformidade:

EN 62841-1:2015
 EN 62841-4-1:2020
 EN IEC 55014-1:2021
 EN IEC 55014-2:2021
 EN ISO 3744:1995

Authorised signatory and technical file holder/signataire et responsable de la documentation technique
authorisé/ podmiot uprawniony do wystawienia i adres prezechowywania dokumentacji technicznej/semnatar
autorizat și deținător al dosarului tehnic/firmante autorizado y titular del expediente tecnico/ signatário
autorizado e detentor da ficha técnica

Kingfisher International Products B.V.,
Rapenburgerstraat 175E,
1011 VM Amsterdam,
The Netherlands



David Awe
Group Quality Director

: [20/04/2022]

TITAN

Manufacturer, Fabricant, Producător, Producător, Fabricante:

UK Manufacturer:

Kingfisher International Products Limited
3 Sheldon Square, London, W2 6PX
United Kingdom
www.kingfisher.com/products

EU Manufacturer:

Kingfisher International Products B.V.
Rapenburgerstraat 175E
1011 VM Amsterdam
The Netherlands
www.kingfisher.com/products

- | | | |
|-----------|--|---|
| EN | www.diy.com
www.screwfix.com
www.screwfix.ie | To view instruction manuals online, visit
www.kingfisher.com/products |
| FR | www.castorama.fr
www.bricodepot.fr | Pour consulter les manuels d'instructions en ligne,
rendez-vous sur le site www.kingfisher.com/products |
| PL | www.castorama.pl | Aby zapoznać się z instrukcją obsługi online, odwiedź
stronę www.kingfisher.com/products |
| ES | www.bricodepot.es | Para consultar los manuales de instrucciones en línea,
visite www.kingfisher.com/products |
| PT | www.bricodepot.pt | Para consultar manuais de instruções online, visite
www.kingfisher.com/products |
| RO | www.bricodepot.ro | Pentru a consulta manualele de instrucțiuni online, vizitați
www.kingfisher.com/products |
| TR | www.koctas.com.tr | Kullanım kılavuzuna internet üzerinden ulaşmak için
www.kingfisher.com/products adresini ziyaret edin |